





Grayhill, Inc.

62S11-H9-060SH

Varenummer:	62S11-H9-060SH
Producent / Mærke:	Grayhill, Inc.
Produkt beskrivelse	ROTARY ENCODER OPTICAL 32PPR
Dataark:	 62S11-H9-060SH.pdf
RoHS Status	 Blyfri / RoHS-kompatibel
Skib fra	Hong Kong
Forsendelsesmåde	DHL/Fedex/TNT/UPS/EMS

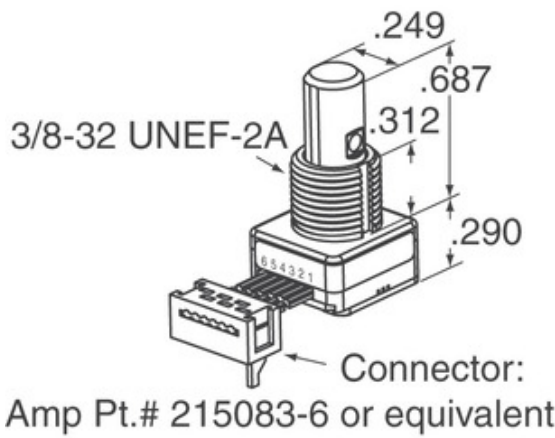

ANMODNING OM TILBUD

Billede kan være repræsentation. Se specifikationer for produktdetaljer.



Specifikationer for 62S11-H9-060SH

VARENUMMER	62S11-H9-060SH
FABRIKANT	Grayhill, Inc.
BESKRIVELSE	ROTARY ENCODER OPTICAL 32PPR
BLYFRI STATUS / ROHS STATUS	Blyfri / RoHS-kompatibel
DATABLAD	 62S11-H9-060SH.pdf
SPÆNDING - SUPPLY	5V
AFLUTNINGSTIL	Cable Leads
SERIE	62S
ROTATIONSLIVET (CYKLER MIN)	1M
PULSER PR. REVOLUTION	32
OUTPUT TYPE	Quadrature (Incremental)
ANDRE NAVNE	62S11H9060SH
ORIENTERING	Vertical
MONTERINGSTYPE	Panel Mount
FUGTFØLSOMHEDSNIVEAU (MSL)	1 (Unlimited)
FABRIKANTENS STANDARD LEDETID	8 Weeks
BLYFRI STATUS / ROHS STATUS	Lead free / RoHS Compliant
ENCODER TYPE	Optical
FASTHOLD	Yes
INDBYGGET SWITCH	Yes
AKTUATOR TYPE	1/4" Dia Flatted End

Relaterede tags

Grayhill, Inc. 62S11-H9-060SH	62S11-H9-060SH-distributør	62S11-H9-060SH-leverandør
62S11-H9-060SH-pris	62S11-H9-060SH-billeder	62S11-H9-060SH-billede
62S11-H9-060SH PDF-datablad	62S11-H9-060SH Download datablad	62S11-H9-060SH-datablad
62S11-H9-060SH Stock	Køb 62S11-H9-060SH	Køb Grayhill, Inc. 62S11-H9-060SH
Grayhill, Inc. 62S11-H9-060SH	Grayhill, Inc.-leverandør	Grayhill, Inc.-distributør
Grayhill, Inc. 62S11-H9-060SH	Grayhill Inc. 62S11-H9-060SH	

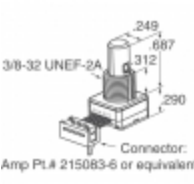
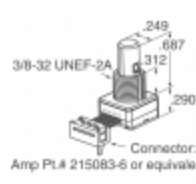
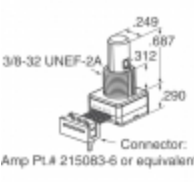
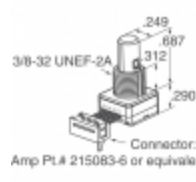
Relaterede produkter

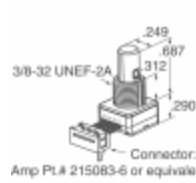
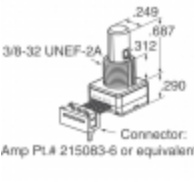
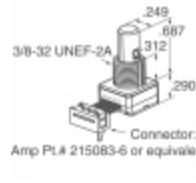
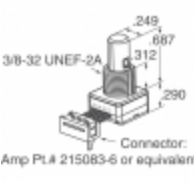
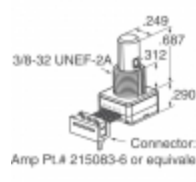
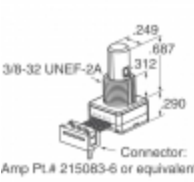
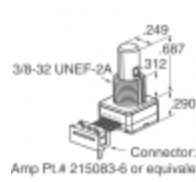
 <p>62S11-L0-040C producenter: Grayhill, Inc. Beskrivelse: ROTARY ENCODER OPTICAL 32PPR På lager: Out stock RFQ</p>	 <p>62S11-H9-050S producenter: Grayhill, Inc. Beskrivelse: ROTARY ENCODER OPTICAL 32PPR På lager: Out stock RFQ</p>
 <p>62S11-L0-020C producenter: Grayhill, Inc. Beskrivelse: ROTARY ENCODER OPTICAL 32PPR På lager: Out stock RFQ</p>	 <p>62S11-L0-020CH producenter: Grayhill, Inc. Beskrivelse: ROTARY ENCODER OPTICAL 32PPR På lager: Out stock RFQ</p>
 <p>62S11-L0-040S producenter: Grayhill, Inc. Beskrivelse: ROTARY ENCODER OPT 32PPR 4" CBL På lager: Out stock RFQ</p>	 <p>62S11-H9-040S producenter: Grayhill, Inc. Beskrivelse: ROTARY ENCODER OPTICAL 32PPR På lager: Out stock RFQ</p>
 <p>62S11-H9-020S producenter: Grayhill, Inc. Beskrivelse: ROTARY ENCODER OPTICAL 32PPR På lager: Out stock RFQ</p>	 <p>62S11-H9-P producenter: Grayhill, Inc. Beskrivelse: ROTARY ENCODER OPTICAL 32PPR På lager: Out stock RFQ</p>
 <p>62S11-H9-PH producenter: Grayhill, Inc. Beskrivelse: ROTARY ENCODER OPTICAL 32PPR På lager: Out stock RFQ</p>	 <p>62S11-H9-025S producenter: Grayhill, Inc. Beskrivelse: ROTARY ENCODER OPTICAL 32PPR På lager: Out stock RFQ</p>
 <p>62S11-H9-060C producenter: Grayhill, Inc. Beskrivelse: ROTARY ENCODER OPTICAL 32PPR På lager: Out stock RFQ</p>	 <p>62S11-H9-040C producenter: Grayhill, Inc. Beskrivelse: ROTARY ENCODER OPTICAL 32PPR På lager: Out stock RFQ</p>